

# VLSI Design Approach for Emergency Locator Transmitter (ELT) signal of 406MHz with Enhanced Ground Proximity Warning System Receiver

K. Babulu,R.S.Vinay

*Department of Electronics and Communication Engineering,  
Jawaharlal Nehru Technological University, Kakinada (JNTUK), Kakinada, India*

**Abstract**---This paper presents an Emergency Locator Transmitter (ELT) and enhanced ground proximity warning system (EGPWS) receiver with the VLSI design. The Emergency Locator Transmitter (ELT) is one of the electronic emergency equipment installed in the aircraft which locates the aircraft after a crash. EGPWS integrates ELT could provide accurate location information to be incorporated in the message of ELT. This new equipment ELT-EGPWS could be incorporated with a lot of added extra features so the equipment can be used for non emergency operations also. This equipment is installed in all the aircraft worldwide and is mandatory by the laws of Civil Aviation throughout the world including India. The ELT automatically activates during the event of a crash using a G switch (Impact Activated Switch).Furthermore, this equipment presents in this paper to implement the techniques to minimize search time and rescue requirements, and to maximize the speed and effectiveness of the Search and Rescue operations after crash of aircraft. The use of the Global Positioning System to determine the latitude and longitude of an emergency situation was coupled with the satellite messaging system.

**Keywords**—Emergency Locator and transmitter Global Positioning System, Enhanced ground Proximity Warning System, GPRS.

## I.INTRODUCTION

Emergency Locator Transmitter (ELT) is a compact, self contained radio transmitter carried on board airplanes to facilitate accurate location and timely rescue operation in event of any distress situation [1]. The integration of a GPS receiver in the existing ELT and re designing the ELT using VLSI technology, would combine very accurate location determination and near instantaneous distress alert [2]. In the past decade, The COSPAS-SARSAT (C/S) [5] satellite system has been providing emergency alerting from system compatible ELT for a number of years and thus, has been instrumental in saving many lives around the world. However, locating the site of the crash using this satellite system is less accurate location, ambiguous and sometimes involves abnormal delay. To avoid that drawback, ELT has been used.

The ELT can provide good location in the aircraft [6]. The drawback of ELT is to find the location of aircraft after a crash of aircraft. By using ELT-EGPWS to avoid those drawbacks. The equipment ELT-EGPWS can provide good location accuracy. The integration of a GPS receiver in the existing ELT and re designing the ELT using VLSI technology, would combine very accurate location determination and near instantaneous distress alert. These

enhancements would reduce the overall time required to complete the rescue operation. The VLSI design of this integrated unit will be compact, efficient and more reliable. The primary objective of this paper is to describe the principles, VLSI design and analysis of an integrated GPS receiver and the ELT so that the GPS receiver could provide location information to be incorporated in the transmitted message of ELT. This article introduces the combination of ELT and EGPWS to reduce the overall time required to complete the rescue operation and near instantaneous alert. The characteristics of ELT-EGPWS of the paper are presented in Section II. Section III describes the Data Aggregation and Authentication (DAA) protocol. The simulation results are presented in Section VI. Concluding remarks are made in Section V.

## II.CHARECTERISICS AND SYSTEM MODEL OF ELT-EGPWS

The ELT activates automatically during a crash and transmits the standard swept tone on 121.5 MHz. and 243.0 MHz. The 406.025 MHz transmitter turns on every 50 seconds. During this time, an encoded digital message is sent to the satellite. Once the ELT-EGPWS is activated and the 406.025 MHz signal is detected, the position of the crash is calculated and then finds the location of aircraft. This location information is less accurate. The 121.5 I 243.0 MHz transmissions are used to home in on the crash site. The 406.025 MHz. transmitter transmits a digital message to the satellite system which helps the search and rescue authorities to contact the operator of the aircraft through a database. The system model as shown below

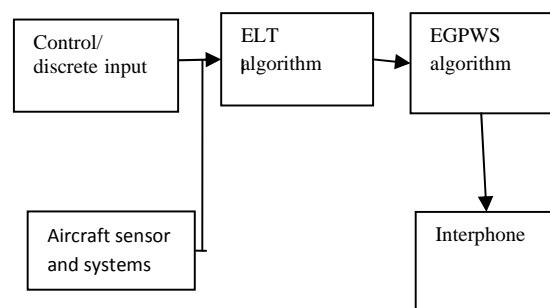

Fig.1. Block diagram of ELT-EGPWS

The block diagram of ELT-EGPWS contains five parts. They are control/discrete input, aircraft sensor and systems, ELT

algorithm, EGPWS algorithm and interphone. ELT algorithm and EGPWS algorithm are explained below. The EGPWS uses aircraft inputs including geographic position, attitude, altitude, airspeed, and glide slope deviation. These are used with internal terrain, obstacles, and airport databases to predict a potential conflict between the aircraft flight path and terrain or an obstacle. A terrain or obstacle conflict results in the EGPWS providing a visual and audio caution or warning alert. Additionally, the EGPWS provides alerts for excessive glide slope deviation, too low with flaps or gear not in landing configuration, and optionally provides bank angle and altitude callouts based on system program pin selection. Detection of severe winds hears conditions are also provided for selected aircraft types when enabled.

### III. ELT ALGORITHM

ELT has to operate on a separate power source as it is not possible to get power from aircraft source after a crash. Normally non rechargeable batteries are used for this purpose. Emergency locator and transmitter consists of the following basics blocks

- Selector
- Manual resets
- Decision circuit
- Blinking light Driver
- Buzzer Driver
- Actuator
- Data Formatter
- Timers and Counters ,oscillators and modulators

*Selector* circuit waits for a pulse from the opto isolator. If it receives a pulse from the opto isolator, then it gives a train of pulses to the decision circuit (no specific specification for the pulses).Has a reset mechanism and resets (stops output) whenever reset input comes from manual reset block.

*Manual reset* Gives a pulse to the selector block when a manual set input is given from the cockpit panel (just like opto-isolator).Gives a reset signal to the decision circuit when a reset is done from the cockpit control panel.

*Decision circuit* has an OR gate which gives an out put pulse for anyone of the inputs. In the output of the OR gate, it checks for correct pulse train (we can set our own, specifications) Blinking light Driver gives pulsating output to drive LED (blinking) while the circuit is operating.

*A buzzer or beeper* is an audio signaling device, which may be mechanical, electromechanical, or electronic. Typical uses of buzzers and beepers include alarms, timers and confirmation of user input such as a mouse click or keystroke An *actuator* is a mechanical device for moving or controlling a mechanism or system. It takes energy, usually transported by air, electric current, or liquid, and converts that into some kind of motion.

*Data formatter* Gives out a coded data output whenever it is activated. Coded data contains fixed and dynamic information. Dynamic data comes from GPS (which can be another module).Depending upon the identification bit type the data format is selected as short message or long message format.

### IV. EGPWS ALGORITHM

The EGPWS uses aircraft inputs including geographic position, attitude, altitude, airspeed, and glide slope deviation. These are used with internal terrain, obstacles, and airport databases to predict a potential conflict between the aircraft flight path and terrain or an obstacle. A terrain or obstacle conflict results in the EGPWS providing a visual and audio caution or warning alert. Additionally, the EGPWS provides alerts for excessive glide slope deviation, too low with flaps or gear not in landing configuration, and optionally provides bank angle and altitude callouts based on system program pin selection. Detection of severe winds hears a condition is also provided for selected aircraft types when enabled.

The basic operation of EGPWS as shown below .A G Switch mounted inside the integrated ELTGPS package activates when it is subjected to a certain level and direction of acceleration. When the unit is activated, a coded 406 MHz signal and 121.5 MHz homing signals are transmitted as per the standard characteristics. The 406 MHz signals contain the last update of the Latitude and Longitude (position of crash site) data from the internal GPS circuits. The unique address of the aircraft identification can be provided in the unit itself, with the help of cluster thumb wheel switches. The data formatter circuit available inside the ELTGPS will format this data along with other details in the standard message format. EGPWS has different modes of operation to detect each type of CFIT. Each mode is processed by comparing the current values of certain flight parameters with pre-set limits. When triggered, each mode outputs a unique voice warning.

#### *Mode 1 - Excessive Descent Rate*

Excessive descent rate, offering alerts and warnings for excessive descent with respect to altitude above ground level (AGL).

#### *Mode 2 – Flight into Rising Terrain*

Rising terrain, to prevent impacting hills and mountains.

#### *Mode 3 – Loss of Altitude after Takeoff*

Descent after takeoff, to prevent "sinking" after initial climb.

#### *Mode 4 – Lack of Altitude Awareness during Cruise Flight*

Terrain clearance, to assure the aircraft simply remains safely above ground.

#### *Mode 5 – Descent below Glide slope on Landing*

Excessive glide slope, to assure the aircraft does not approach the runway too high or too low.

#### *Mode 6 – Altitude Awareness during Final Approach*

Advisory callouts, for when the aircraft descends through predefined altitudes below 2,500 feet AGL or a decision height set on the radio altimeter, or when bank angles become too steep.

#### *Mode 7 – Microburst Winds hear*

Reactive winds hear.

### V. SYSTEM TESTING

Detailed testing of the unit has to be done in the various combinations of scenarios to ensure that the unit would operate as intended. The tests planned to conduct are the temperature tests, floatation tests, automatic release tests,

satellite tests etc. These tests are the part of the performance analysis and analytical study of the newly designed ELTGPS. The detailed performance analysis involves the de-tailed study on the device with respect to operating characteristics, speed of processing of information inside the integrated circuits, compatibility with different aircraft and systems, transmission characteristics, simplicity in the handling of the devices and testing, reliability issues, precision of the system etc.

**VI.EXPERIMENTAL RESULTS**

The VLSI implementation of ELT includes the design of display unit to which latitude and longitude are the inputs and this information is to be displayed in the cockpit. The data formatter is very important block of design which takes country code, serial code, operator code, latitude, longitudes, as inputs and generates 144-bits output which includes the CRC checksum. The error-correction code which we are using here is the BCH. this generates a checksum depending on polynomial chosen. Here we have used the 16-bit polynomial  $x^{16}+x^2+1$ . The logic of the ELT is also design by considering emergency or manual test to make buzzer and blinking light ON.

For the design of all these units the hardware description language VHDL is used. The simulation of design is done by using Active-HDL 4.2 SE and synthesis is by ISE SIMULATOR, Xilinx 9.2 i. This synthesis tool generated the gate level circuit for which layouts can be drawn by automatic layout generator and this tape out should be to the fabrication centre for chip design. Simulation diagram for ELT is as shown in the Fig.2.

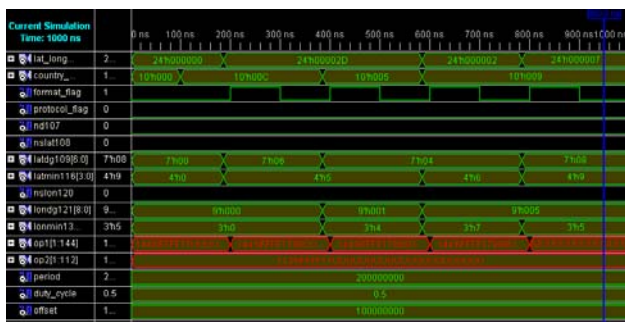

Fig. 2. Simulation diagram of ELT.

Pin diagram of ELT is shown in the Fig.3.

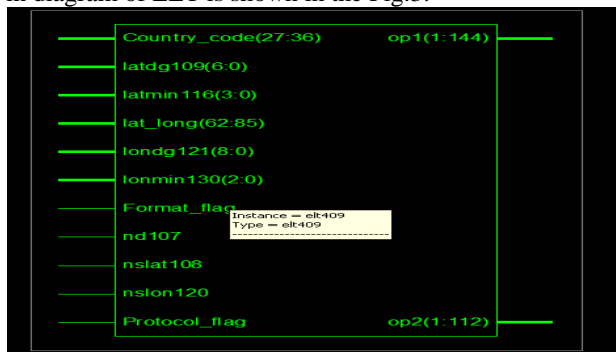

Fig. 3. Pin diagram of ELT.

RTL Schematic of ELT is shown in Fig.4.

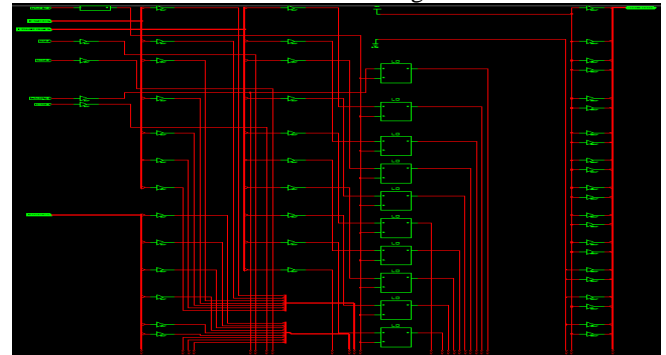

Fig. 4. RTL Schematic of ELT.

Simulation diagram for EGPWS is as shown in Fig. 5

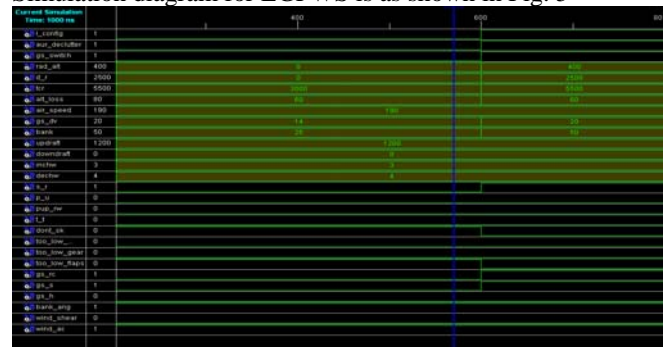

Fig. 5. Simulation diagram of EGPWS.

Pin diagram of EGPWS is shown in Fig. 6.

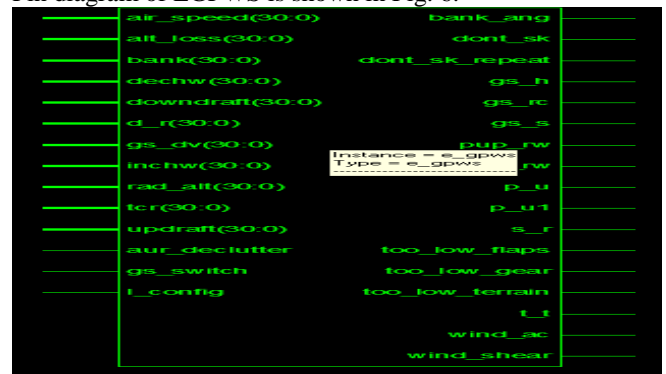

Fig. 6. Pin diagram of EGPWS.

RTL Schematic of EGPWS is shown in Fig.7.

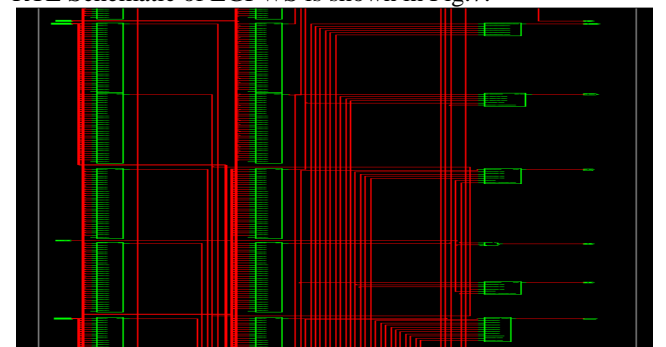

Fig. 7. RTL Schematic of EGPWS.

## VII. CONCLUSION

The objective of initiation to develop the techniques to minimize search time and rescue requirements, and to maximize the speed and effectiveness of the Search and Rescue operations after crash of aircraft. The use of the Positioning System to determine the latitude and longitude of an emergency situation was coupled with the satellite messaging system of the 406.025 MHz COSPAS-SARSAT emergency alerting system to substantially improve the accuracy and speed of an alert notification. The work involves a revision of the COSPAS-SARSAT system specifications and the design, development and construction of the prototypes. Tests are to be carried out to show its potential for saving time and costs during search and rescue. These units are a world-wide first for demonstrating an ELTGPS with all its additional capabilities.

## REFERENCES

- [1] Albert Helprick., "Principles of Avionics", Avionics Communications Inc, Post Box 2628, Leesburg, VA 20177, USA, 2000.
- [2] Hans M.Soekkha., "Aviation Safety – Integrated safety Systems Design and Air Transport Safety", VSP, Post Box 346, 3700 AH Zeist, The Netherlands, 1997.
- [3] J. Powell., "Aircraft Radio Systems", Pitman Pub-lishers, Bristol, England, 1992.
- [4] FCC Code of Federal Regulations, Title 47, Chapter 1, Part 87.Huangb, and Te-Ming Tua "A Novel Image Steganographic Method Using Tri-way Pixel-Value Differencing" 2008 academy publisher.
- [5] "Specifications of COSPOS-SARSAT 406 MHz Distress Beacons", (C/S T.001 Issue 3, Rev.3), Co-spos-Sarsat Secretariat, October 1999.
- [6] "COSPOS SARSAT 406 MHz Distress Beacon Type Approval Standard", (C/S T .007 Issue 3, Re-vision 6), Cospos-Sarsat Secretariat, October 1999.
- [7] "406 MHz Emergency Locator Transmitter (ELT)", Technical Standards Order TSO-C 126, December 23, 1992.
- [8] Michael John Sebastian Smith., "Applications Specific Integrated Circuits", Addison-Wesley, An Imprint of Pearson Education, 2000.
- [9] Michael John Sebastian Smith., "Applications Specific Integrated Circuits", Addison-Wesley, An Imprint of Pearson Education, 2000.
- [10] Perry,D.,VHDL Programming by Example, New York: McGraw Hill,1991
- [11] Navabi, Z., VHDL Analysis and Modeling of Digital Systems,McGraw Hill, 1993
- [12] Bhasker.J., VHDL PRIMER , Addison Wesley Longman Singapore Pte.Ltd. LPE,2000.